

350mA, Ultra-Low V_{IN} , RF Low-Dropout Linear Regulator with Bias Pin

FEATURES

- 350mA High-Performance LDO
- Low Quiescent Current: 38 μ A
- Excellent Load Transient Response:
 $\pm 15\text{mV}$ for $I_{LOAD} = 0\text{mA}$ to 350mA in 1 μ s
- Excellent Line Transient Response:
 $\Delta V_{OUT} = \pm 2\text{mV}$ for $\Delta V_{BIAS} = \pm 600\text{mV}$ in 1 μ s
 $\Delta V_{OUT} = \pm 200\mu\text{V}$ for $\Delta V_{IN} = \pm 400\text{mV}$ in 1 μ s
- Low Noise: 48 μ V_{RMS} (10Hz to 100kHz)
- 80dB V_{IN} PSRR (10Hz to 10kHz)
- 70dB V_{BIAS} PSRR (10Hz to 10kHz)
- Fast Start-Up Time: 140 μ s
- Built-In Soft-Start with Monotonic V_{OUT} Rise and Startup Current Limited to 100mA + I_{LOAD}
- Over-Current and Thermal Protection
- Low Dropout: 110mV at $I_{LOAD} = 350\text{mA}$
- Stable with 2.2 μ F Output Capacitor
- Available in 1,33mm x 0,96mm WCSP-5 and 2mm x 2mm SON-6 Packages

APPLICATIONS

- Digital Cameras
- Cellular Camera Phones
- Wireless LAN
- Handheld Products

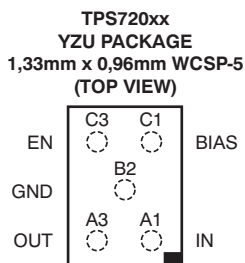
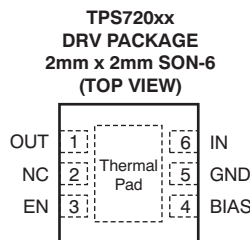

DESCRIPTION

The TPS720xx family of dual rail, low-dropout linear regulators (LDOs) offers outstanding ac performance (PSRR, load and line transient response), while consuming a very low quiescent current of 38 μ A.

The V_{BIAS} rail that powers the control circuit of the LDO draws very low current (on the order of the quiescent current of the LDO) and can be connected to any power supply that is equal to or greater than 1.4V above the output voltage. The main power path is through V_{IN} , which can be a lower voltage than V_{BIAS} ; it can be as low as $V_{OUT} + V_{DO}$, increasing the efficiency of the solution in many power-sensitive applications. For example, V_{IN} can be an output of a high-efficiency, dc-dc step-down regulator.

The TPS720xx supports a novel feature in which the output of the LDO regulates under light loads when the IN pin is left floating. The light-load drive current is sourced from V_{BIAS} under this condition. This feature is particularly useful in power-saving applications where the dc/dc converter connected to the IN pin is disabled but the LDO is still required to regulate the voltage to a light load.

The TPS720xx is stable with ceramic capacitors and uses an advanced BICMOS fabrication process that yields a dropout of 110mV at a 350mA output load. The TPS720xx has the unique feature of providing a monotonic V_{OUT} rise (overshoot limited to 3%) with V_{IN} inrush current limited to 100mA + I_{LOAD} with an output capacitor of 2.2 μ F.

The TPS720xx uses a precision voltage reference and feedback loop to achieve overall accuracy of 2% over load, line, process, and temperature extremes. An ultra-small wafer chip-scale package (WCSP) makes the TPS720xx ideal for handheld applications. The TPS720xx is also available in a SON-8 package. This family of devices is fully specified over the temperature range of $T_J = -40^{\circ}\text{C}$ to $+125^{\circ}\text{C}$.

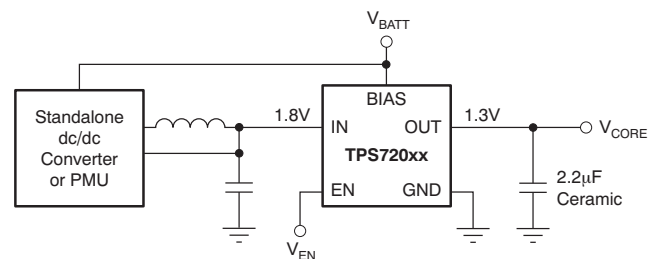

Please be aware that an important notice concerning availability, standard warranty, and use in critical applications of Texas Instruments semiconductor products and disclaimers thereto appears at the end of this data sheet.

All trademarks are the property of their respective owners.



This integrated circuit can be damaged by ESD. Texas Instruments recommends that all integrated circuits be handled with appropriate precautions. Failure to observe proper handling and installation procedures can cause damage.

ESD damage can range from subtle performance degradation to complete device failure. Precision integrated circuits may be more susceptible to damage because very small parametric changes could cause the device not to meet its published specifications.

ORDERING INFORMATION⁽¹⁾

PRODUCT	V _{OUT} ⁽²⁾
TPS720xxyyyz	XX is nominal output voltage (for example, 28 = 2.8V, 285 = 2.85V). YYY is the package designator. Z is tape and reel quantity (R = 3000, T = 250).

- (1) For the most current package and ordering information see the Package Option Addendum at the end of this document, or see the TI website at www.ti.com.
- (2) Output voltages from 0.9V to 3.6V in 50mV increments are available through the use of innovative factory EEPROM programming; minimum order quantities may apply. Contact factory for details and availability.

ABSOLUTE MAXIMUM RATINGS⁽¹⁾

At T_J = –40°C to +125°C (unless otherwise noted). All voltages are with respect to GND.

PARAMETER	TPS720xx	UNIT
Input voltage range (steady-state), V _{IN} ⁽²⁾	–0.3 to V _{BIAS} or +5.0 ⁽³⁾	V
Peak transient input voltage, V _{IN_PEAK} ⁽⁴⁾	+5.5	V
Bias voltage range, V _{BIAS}	–0.3 to +6.0	V
Enable voltage range, V _{EN}	–0.3 to +6.0	V
Output voltage range, V _{OUT}	–0.3 to +5.0	V
Peak output current, I _{OUT}	Internally limited	
Output short-circuit duration	Indefinite	
Total continuous power dissipation, P _{DISS}	See Dissipation Ratings Table	
ESD rating	Human body model (HBM)	2000
	Charged device model (CDM)	500
	Machine model (MM)	100
Operating junction temperature range, T _J	–55 to +125	°C
Storage temperature range, T _{STG}	–55 to +150	°C

- (1) Stresses above these ratings may cause permanent damage. Exposure to absolute maximum conditions for extended periods may degrade device reliability. These are stress ratings only, and functional operation of the device at these or any other conditions beyond those specified is not implied.
- (2) To ensure proper operation of the device it is necessary that V_{IN} ≤ V_{BIAS} under all conditions.
- (3) Whichever is less.
- (4) For durations no longer than 1ms each, for a total of no more than 1000 occurrences over the lifetime of the device.

DISSIPATION RATINGS

BOARD	PACKAGE	R _{θJC}	R _{θJA}	DERATING FACTOR ABOVE T _A = +25°C	T _A < +25°C	T _A = +70°C	T _A = +85°C
High-K ⁽¹⁾	YZU	51°C/W	248°C/W	4mW/°C	403mW	222mW	160mW
High-K ⁽¹⁾	DRV	20°C/W	65°C/W	15.4mW/°C	1580mW	845mW	615mW

- (1) The JEDEC high-K (2s2p) board used to derive this data was a 3- x 3-inch, multilayer board with 1-ounce internal power and ground planes and 2-ounce copper traces on top and bottom of the board.

ELECTRICAL CHARACTERISTICS

Over operating temperature range ($T_J = -40^\circ\text{C}$ to $+125^\circ\text{C}$), $V_{\text{BIAS}} = (V_{\text{OUT}} + 1.4\text{V})$ or 2.5V (whichever is greater); $V_{\text{IN}} \geq V_{\text{OUT}} + 0.5\text{V}$, $I_{\text{OUT}} = 1\text{mA}$, $V_{\text{EN}} = 1.1\text{V}$, $C_{\text{OUT}} = 2.2\mu\text{F}$, unless otherwise noted. Typical values are at $T_J = +25^\circ\text{C}$.

PARAMETER		TEST CONDITIONS	MIN	TYP	MAX	UNIT	
V_{IN}	Input voltage range		1.1 ⁽¹⁾	V_{BIAS} or 4.5 ⁽²⁾		V	
V_{BIAS}	Bias voltage range		2.5		5.5	V	
$V_{\text{OUT}}^{(3)}$	Output voltage range ⁽⁴⁾		0.9		3.6	V	
	Output accuracy	Nominal $T_J = +25^\circ\text{C}$		-3.0		+3.0	mV
		Over V_{BIAS} , V_{IN} , I_{OUT} , $T_J = -40^\circ\text{C}$ to $+125^\circ\text{C}$	$V_{\text{OUT}} + 1.4\text{V} \leq V_{\text{BIAS}} \leq 5.5\text{V}$, $V_{\text{OUT}} + 0.5\text{V} \leq V_{\text{IN}} \leq 4.5\text{V}$, $0\text{mA} \leq I_{\text{OUT}} \leq 350\text{mA}$	-2.0		+2.0	%
		Over V_{BIAS} , V_{IN} , I_{OUT} , $T_J = -10^\circ\text{C}$ to $+85^\circ\text{C}$	$V_{\text{OUT}} + 1.4\text{V} \leq V_{\text{BIAS}} \leq 5.5\text{V}$, $V_{\text{OUT}} + 0.5\text{V} \leq V_{\text{IN}} \leq 4.5\text{V}$, $0\text{mA} \leq I_{\text{OUT}} \leq 350\text{mA}$ $1.6\text{V} \leq V_{\text{OUT}} \leq 3.3\text{V}$	-1.0		+1.0	%
V_{IN} floating	$V_{\text{OUT}} + 1.4\text{V} \leq V_{\text{BIAS}} \leq 5.5\text{V}$, $0\mu\text{A} \leq I_{\text{OUT}} \leq 500\mu\text{A}$		± 1.0		%		
$\Delta V_{\text{OUT}}/\Delta V_{\text{IN}}$	V_{IN} line regulation	$V_{\text{IN}} = (V_{\text{OUT}} + 0.5\text{V})$ to 4.5V , $I_{\text{OUT}} = 1\text{mA}$		16		$\mu\text{V}/\text{V}$	
$\Delta V_{\text{OUT}}/\Delta V_{\text{BIAS}}$	V_{BIAS} line regulation	$V_{\text{BIAS}} = (V_{\text{OUT}} + 1.4\text{V})$ or 2.5V (whichever is greater) to 5.5V , $I_{\text{OUT}} = 1\text{mA}$		16		$\mu\text{V}/\text{V}$	
	V_{IN} line transient	$\Delta V_{\text{IN}} = 400\text{mV}$, $t_{\text{RISE}} = t_{\text{FALL}} = 1\mu\text{s}$		± 200		μV	
	V_{BIAS} line transient	$\Delta V_{\text{BIAS}} = 600\text{mV}$, $t_{\text{RISE}} = t_{\text{FALL}} = 1\mu\text{s}$		± 0.8		mV	
$\Delta V_{\text{OUT}}/\Delta I_{\text{OUT}}$	Load regulation	$0\text{mA} \leq I_{\text{OUT}} \leq 350\text{mA}$ (no load to full load)		-15		$\mu\text{V}/\text{mA}$	
	Load transient	$0\text{mA} \leq I_{\text{OUT}} \leq 350\text{mA}$, $t_{\text{RISE}} = t_{\text{FALL}} = 1\mu\text{s}$		± 15		mV	
$V_{\text{DO_IN}}$	V_{IN} dropout voltage ⁽⁵⁾	$V_{\text{IN}} = V_{\text{OUT(NOM)}} - 0.1\text{V}$, $(V_{\text{BIAS}} - V_{\text{OUT(NOM)}}) = 1.4\text{V}$, $I_{\text{OUT}} = 350\text{mA}$		110	200	mV	
$V_{\text{DO_BIAS}}$	V_{BIAS} dropout voltage ⁽⁶⁾	$V_{\text{IN}} = V_{\text{OUT(NOM)}} + 0.3\text{V}$, $I_{\text{OUT}} = 350\text{mA}$		1.09	1.4	V	
I_{CL}	Output current limit	$V_{\text{OUT}} = 0.9 \times V_{\text{OUT(NOM)}}$	420	525	800	mA	
I_{GND}	Ground pin current	$I_{\text{OUT}} = 100\mu\text{A}$		38		μA	
		$I_{\text{OUT}} = 0\text{mA}$ to 350mA		54	80	μA	
I_{SHDN}	Shutdown current (I_{GND})	$V_{\text{EN}} \leq 0.4\text{V}$, $T_J = -40^\circ\text{C}$ to $+85^\circ\text{C}$		0.5	2	μA	
PSRR	V_{IN} power-supply rejection ratio	$V_{\text{IN}} - V_{\text{OUT}} \geq 0.5\text{V}$, $V_{\text{BIAS}} = V_{\text{OUT}} + 1.4\text{V}$, $I_{\text{OUT}} = 350\text{mA}$	$f = 10\text{Hz}$		85	dB	
			$f = 100\text{Hz}$		85	dB	
			$f = 1\text{kHz}$		85	dB	
			$f = 10\text{kHz}$		80	dB	
			$f = 100\text{kHz}$		70	dB	
	V_{BIAS} power-supply rejection ratio	$V_{\text{IN}} - V_{\text{OUT}} \geq 0.5\text{V}$, $V_{\text{BIAS}} = V_{\text{OUT}} + 1.4\text{V}$, $I_{\text{OUT}} = 350\text{mA}$	$f = 1\text{MHz}$		50	dB	
			$f = 10\text{Hz}$		80	dB	
			$f = 100\text{Hz}$		80	dB	
			$f = 1\text{kHz}$		75	dB	
			$f = 10\text{kHz}$		65	dB	
$f = 100\text{kHz}$		55	dB				
$f = 1\text{MHz}$		35	dB				
V_{N}	Output noise voltage	$\text{BW} = 10\text{Hz}$ to 100kHz , $V_{\text{BIAS}} \geq 2.5\text{V}$, $V_{\text{IN}} = V_{\text{OUT}} + 0.5\text{V}$		48		μV_{RMS}	
$I_{\text{VIN_INRUSH}}$	Inrush current on V_{IN}	$V_{\text{BIAS}} = (V_{\text{OUT}} + 1.4\text{V})$ or 2.5V (whichever is greater), $V_{\text{IN}} = V_{\text{OUT}} + 0.5\text{V}$		$100 + I_{\text{LOAD}}$		mA	

(1) Performance specifications are ensured up to a minimum $V_{\text{IN}} = V_{\text{OUT}} + 0.5\text{V}$.

(2) Whichever is less.

(3) Minimum $V_{\text{BIAS}} = (V_{\text{OUT}} + 1.4\text{V})$ or 2.5V (whichever is greater) and $V_{\text{IN}} = V_{\text{OUT}} + 0.5\text{V}$.

(4) V_{O} nominal value is factory programmable through the onchip EEPROM.

(5) Measured for devices with $V_{\text{OUT(NOM)}} \geq 1.2\text{V}$.

(6) $V_{\text{BIAS}} - V_{\text{OUT}}$ with $V_{\text{OUT}} = V_{\text{OUT(NOM)}} - 0.1\text{V}$. Measured for devices with $V_{\text{OUT(NOM)}} \geq 1.8\text{V}$.

ELECTRICAL CHARACTERISTICS (continued)

Over operating temperature range ($T_J = -40^{\circ}\text{C}$ to $+125^{\circ}\text{C}$), $V_{BIAS} = (V_{OUT} + 1.4\text{V})$ or 2.5V (whichever is greater); $V_{IN} \geq V_{OUT} + 0.5\text{V}$, $I_{OUT} = 1\text{mA}$, $V_{EN} = 1.1\text{V}$, $C_{OUT} = 2.2\mu\text{F}$, unless otherwise noted. Typical values are at $T_J = +25^{\circ}\text{C}$.

PARAMETER		TEST CONDITIONS	MIN	TYP	MAX	UNIT
t_{STR}	Startup time	$V_{OUT} = 95\% V_{OUT(NOM)}$, $I_{OUT} = 350\text{mA}$, $C_{OUT} = 2.2\mu\text{F}$		140		μs
$V_{EN(HI)}$	Enable pin high (enabled)		1.1			V
$V_{EN(LO)}$	Enable pin low (disabled)		0		0.4	V
I_{EN}	Enable pin current	$V_{EN} = 5.5\text{V}$, $V_{IN} = 4.5\text{V}$, $V_{BIAS} = 5.5\text{V}$			1.0	μA
UVLO	Undervoltage lockout	V_{BIAS} rising	2.41	2.45	2.49	V
	Hysteresis	V_{BIAS} falling		150		mV
T_{SD}	Thermal shutdown temperature	Shutdown, temperature increasing		+160		$^{\circ}\text{C}$
		Reset, temperature decreasing		+140		$^{\circ}\text{C}$
T_J	Operating junction temperature		-40		+125	$^{\circ}\text{C}$

DEVICE INFORMATION

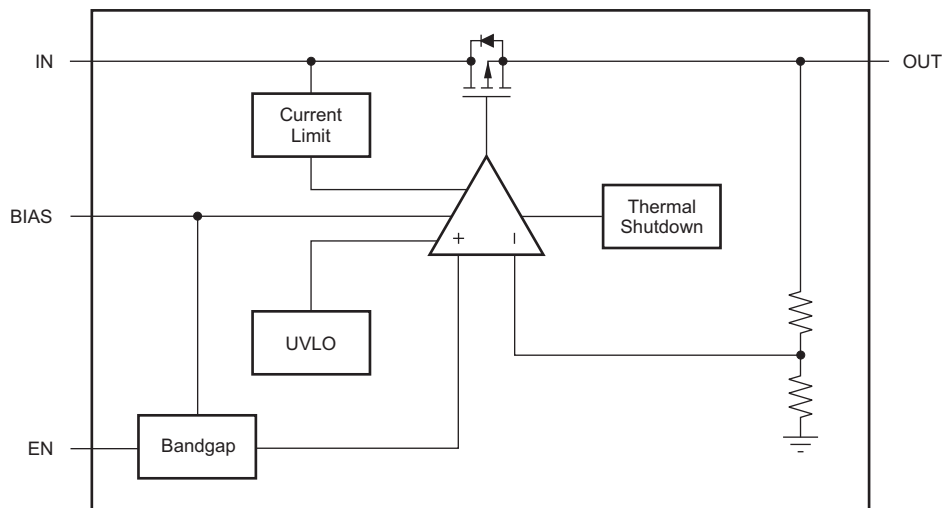

Functional Block Diagram

PIN CONFIGURATION

**DRV PACKAGE
SON-6
(TOP VIEW)**

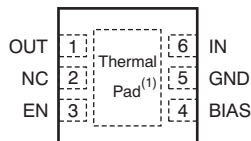

- (1) It is recommended that the SON (DRV) package thermal pad be connected to ground.

**YZU PACKAGE
WCSP-5
(TOP VIEW)**

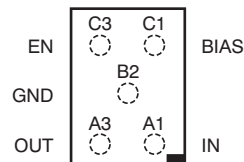

PIN DESCRIPTIONS

TPS720xx			DESCRIPTION
NAME	DRV	YZU	
OUT	1	A3	Output pin. A 2.2 μ F ceramic capacitor is connected from this pin to ground, for stability and to provide load transients. See Input and Output Capacitor Requirements in the <i>Application Information</i> section.
NC	2	—	No connection.
EN	3	C3	Enable pin. A logic high signal on this pin turns the device on and regulates the voltage from IN to OUT. A logic low on this pin turns off the device.
BIAS	4	C1	Bias supply pin. It is recommended that this input be bypassed with a ceramic capacitor to ground for better transient performance. See Input and Output Capacitor Requirements in the <i>Application Information</i> section.
GND	5	B2	Ground pin.
IN	6	A1	Input pin. This pin can be a maximum of 4.5V; V_{IN} must not exceed V_{BIAS} . Bypass this input with a ceramic capacitor to ground. See Input and Output Capacitor Requirements in the <i>Application Information</i> section.

TYPICAL CHARACTERISTICS

Over operating temperature range ($T_J = -40^{\circ}\text{C}$ to $+125^{\circ}\text{C}$), $V_{BIAS} = (V_{OUT} + 1.4\text{V})$ or 2.5V (whichever is greater); $V_{IN} = V_{OUT} + 0.5\text{V}$, $I_{OUT} = 1\text{mA}$, $V_{EN} = 1.1\text{V}$, $C_{OUT} = 2.2\mu\text{F}$, unless otherwise noted. Typical values are at $T_J = +25^{\circ}\text{C}$.

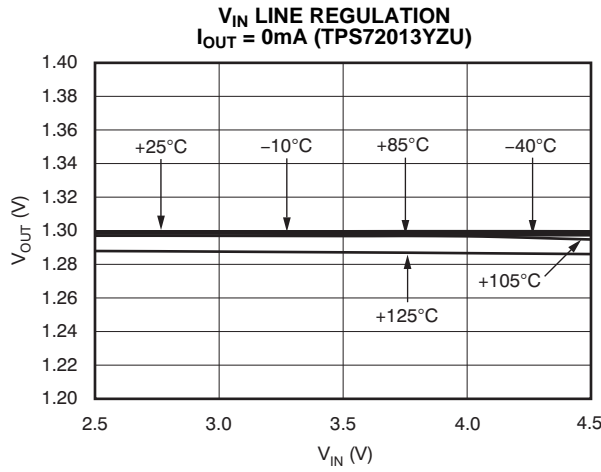

Figure 1.

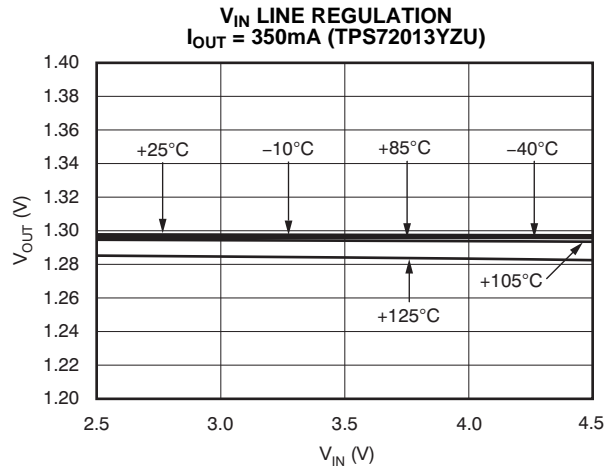

Figure 2.

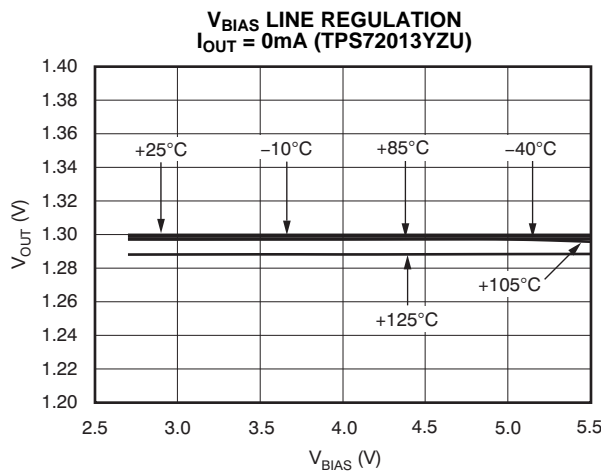

Figure 3.

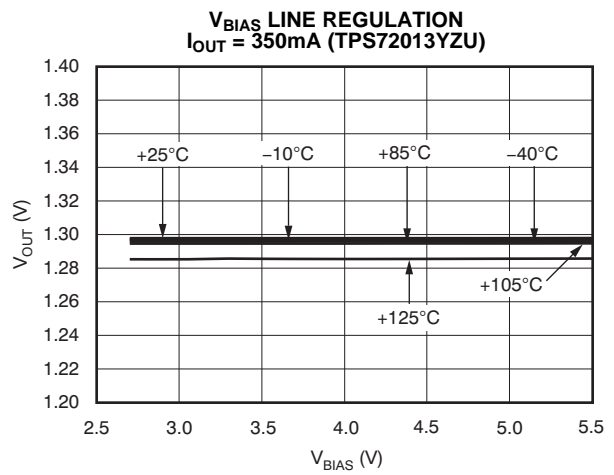

Figure 4.

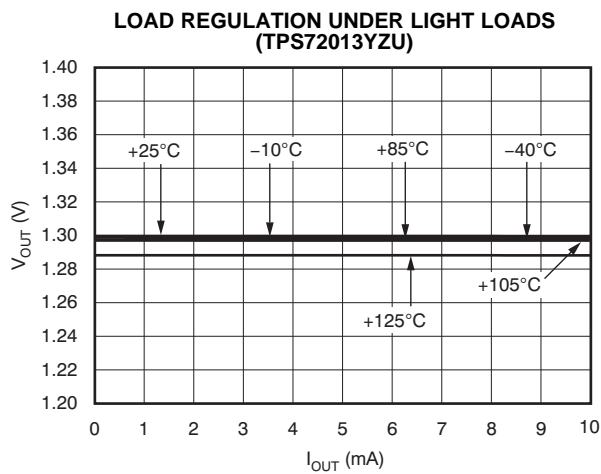

Figure 5.

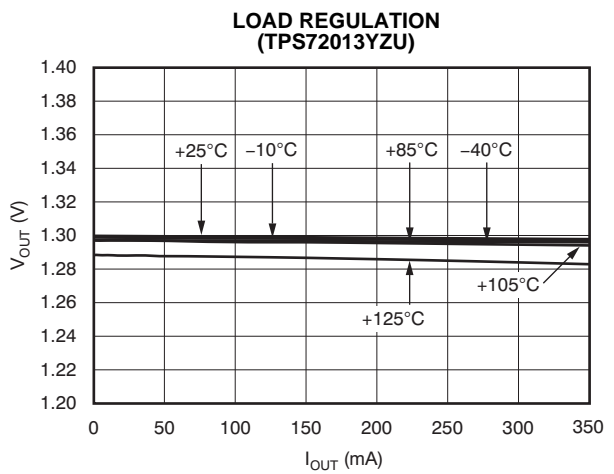

Figure 6.

TYPICAL CHARACTERISTICS (continued)

Over operating temperature range ($T_J = -40^{\circ}\text{C}$ to $+125^{\circ}\text{C}$), $V_{BIAS} = (V_{OUT} + 1.4\text{V})$ or 2.5V (whichever is greater); $V_{IN} = V_{OUT} + 0.5\text{V}$, $I_{OUT} = 1\text{mA}$, $V_{EN} = 1.1\text{V}$, $C_{OUT} = 2.2\mu\text{F}$, unless otherwise noted. Typical values are at $T_J = +25^{\circ}\text{C}$.

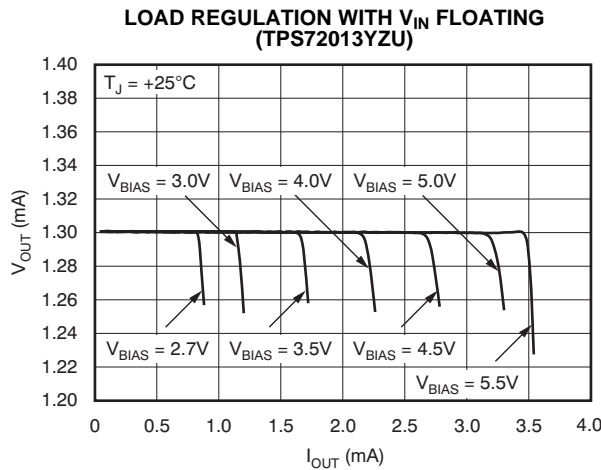

Figure 7.

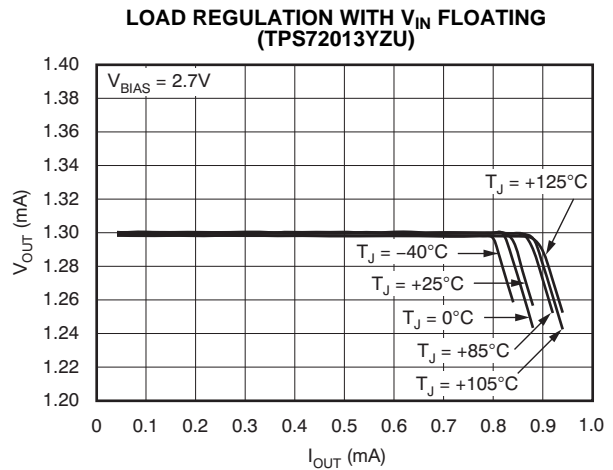

Figure 8.

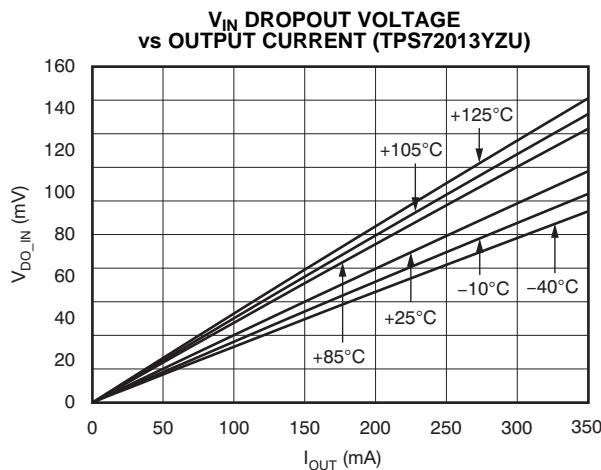

Figure 9.

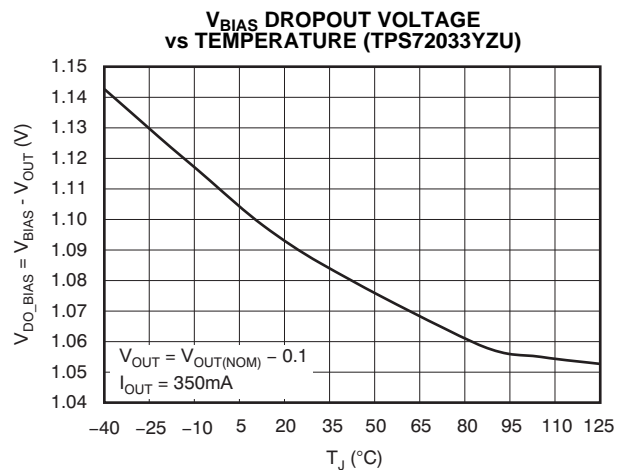

Figure 10.

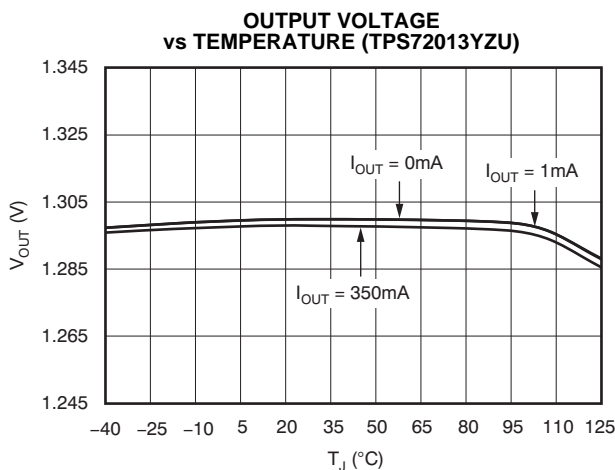

Figure 11.

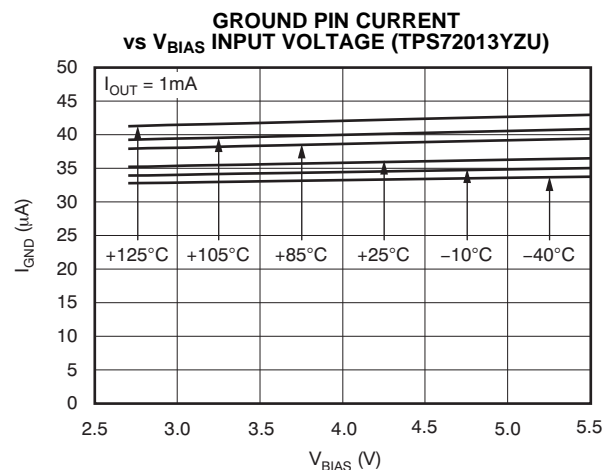

Figure 12.

TYPICAL CHARACTERISTICS (continued)

Over operating temperature range ($T_J = -40^{\circ}\text{C}$ to $+125^{\circ}\text{C}$), $V_{\text{BIAS}} = (V_{\text{OUT}} + 1.4\text{V})$ or 2.5V (whichever is greater); $V_{\text{IN}} = V_{\text{OUT}} + 0.5\text{V}$, $I_{\text{OUT}} = 1\text{mA}$, $V_{\text{EN}} = 1.1\text{V}$, $C_{\text{OUT}} = 2.2\mu\text{F}$, unless otherwise noted. Typical values are at $T_J = +25^{\circ}\text{C}$.

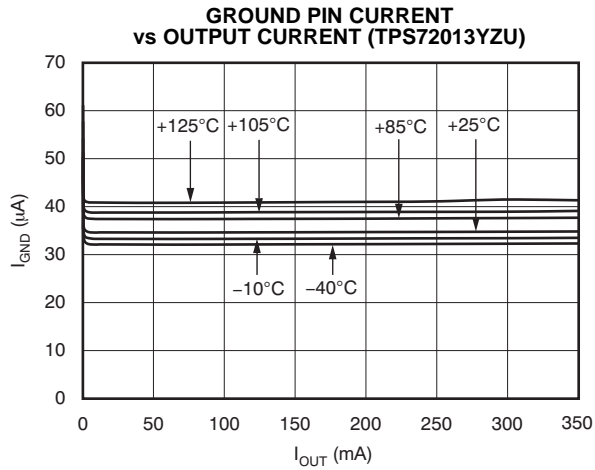

Figure 13.

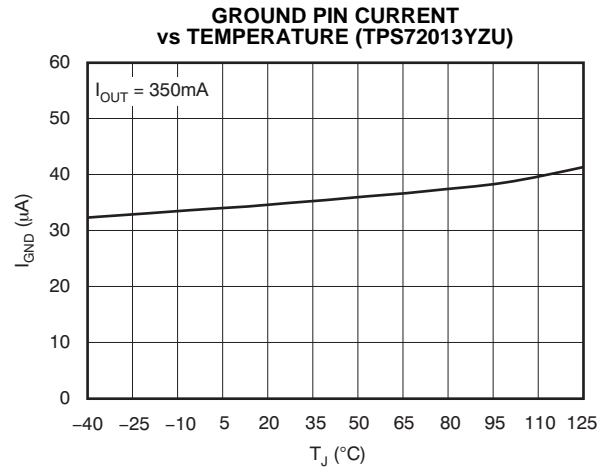

Figure 14.

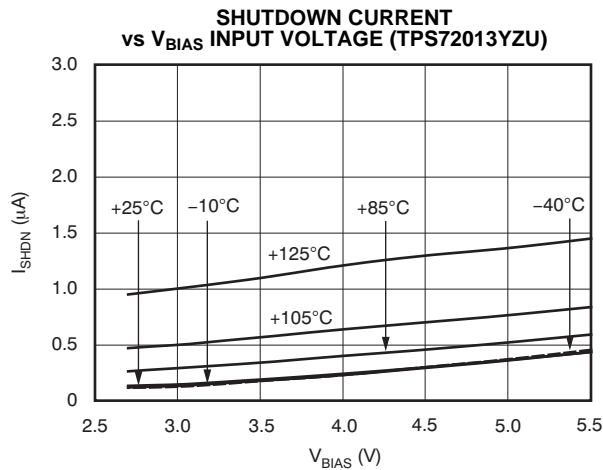

Figure 15.

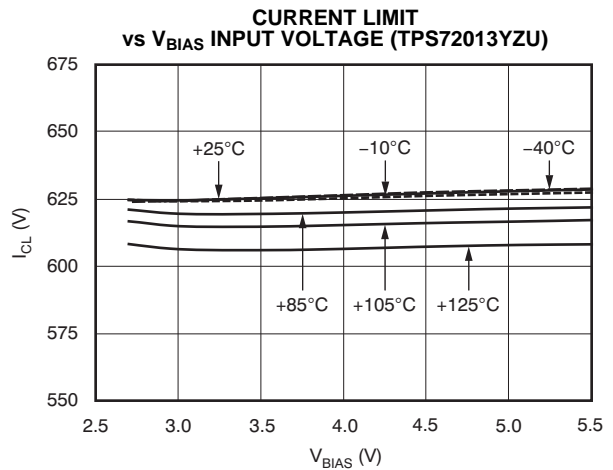

Figure 16.

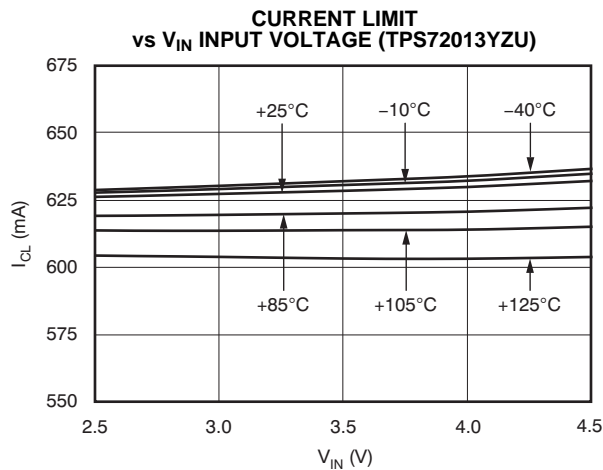

Figure 17.

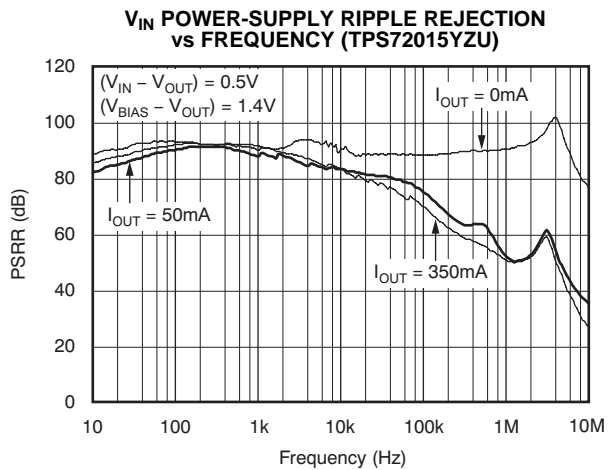

Figure 18.

TYPICAL CHARACTERISTICS (continued)

Over operating temperature range ($T_J = -40^{\circ}\text{C}$ to $+125^{\circ}\text{C}$), $V_{BIAS} = (V_{OUT} + 1.4\text{V})$ or 2.5V (whichever is greater); $V_{IN} = V_{OUT} + 0.5\text{V}$, $I_{OUT} = 1\text{mA}$, $V_{EN} = 1.1\text{V}$, $C_{OUT} = 2.2\mu\text{F}$, unless otherwise noted. Typical values are at $T_J = +25^{\circ}\text{C}$.

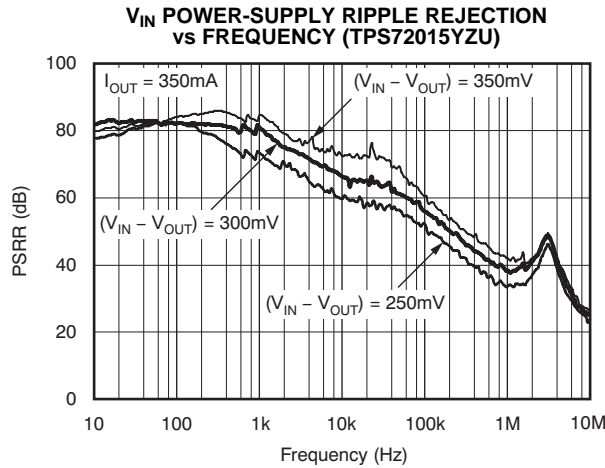

Figure 19.

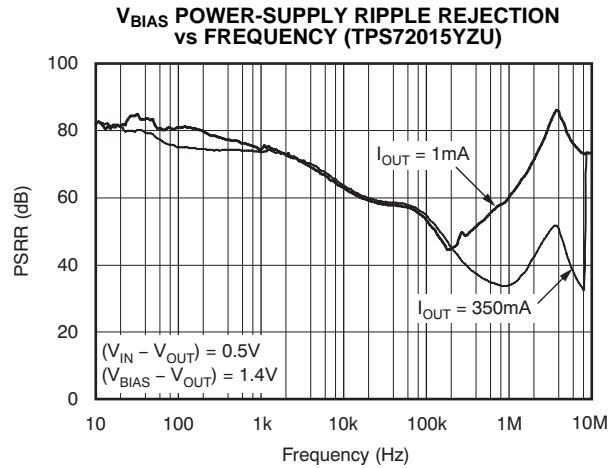

Figure 20.

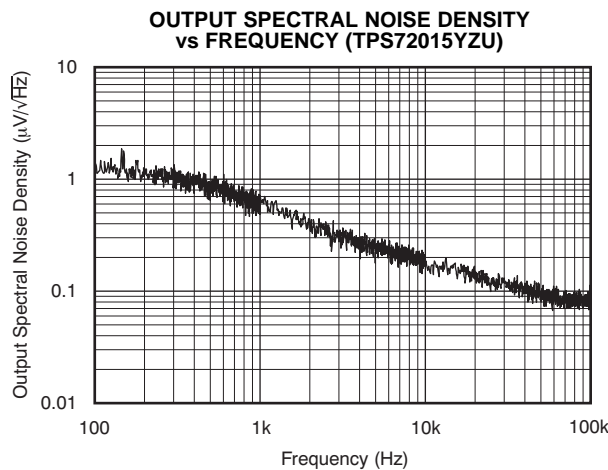

Figure 21.

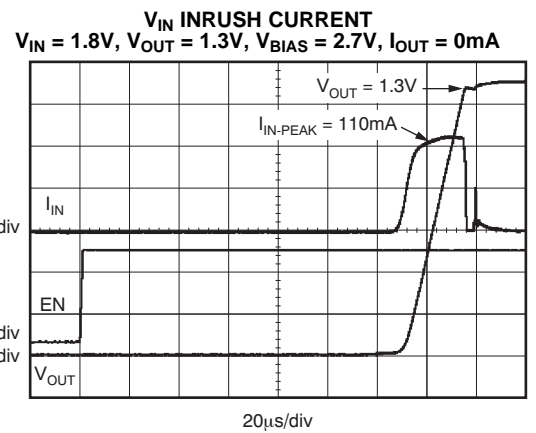

Figure 22.

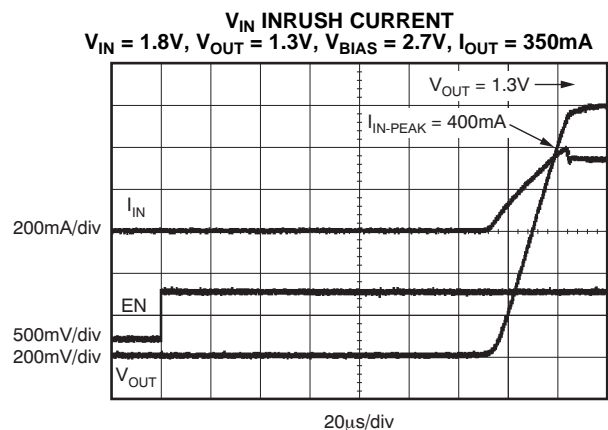

Figure 23.

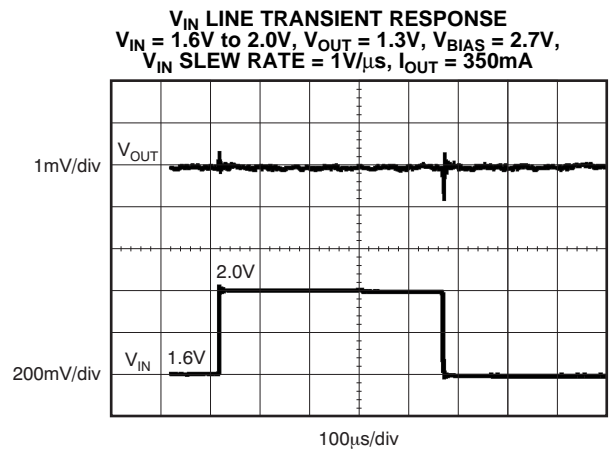

Figure 24.

TYPICAL CHARACTERISTICS (continued)

Over operating temperature range ($T_J = -40^{\circ}\text{C}$ to $+125^{\circ}\text{C}$), $V_{BIAS} = (V_{OUT} + 1.4\text{V})$ or 2.5V (whichever is greater); $V_{IN} = V_{OUT} + 0.5\text{V}$, $I_{OUT} = 1\text{mA}$, $V_{EN} = 1.1\text{V}$, $C_{OUT} = 2.2\mu\text{F}$, unless otherwise noted. Typical values are at $T_J = +25^{\circ}\text{C}$.

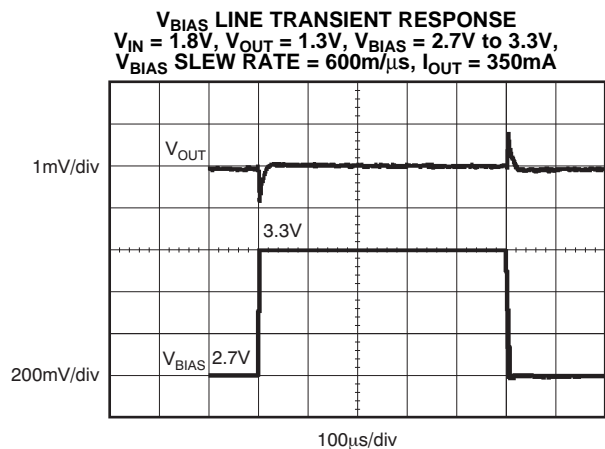

Figure 25.

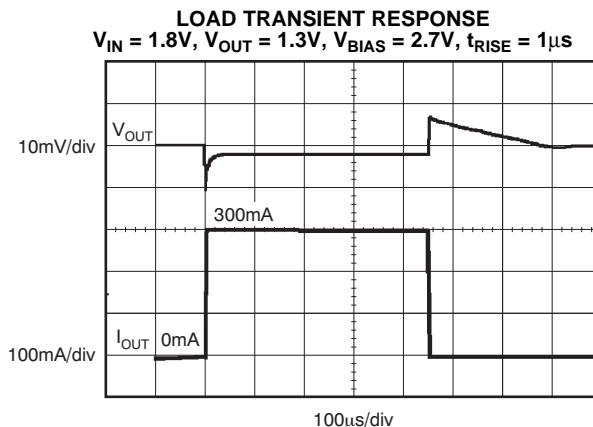

Figure 26.

APPLICATION INFORMATION

The TPS720xx belongs to a family of new generation LDO regulators that use innovative circuitry to achieve ultra-wide bandwidth and high loop gain, resulting in extremely high PSRR (up to 1MHz) at very low headroom ($V_{IN} - V_{OUT}$). The implementation of the BIAS pin on the TPS720xx vastly improves efficiency of low V_{OUT} applications by allowing the use of a preregulated, low-voltage input supply. The TPS720xx supports a novel feature in which the output of the LDO regulates under light loads (<500 μ A) when the IN pin is left floating. The light-load drive current is sourced from V_{BIAS} under this condition. This feature is particularly useful in power-saving applications where the dc/dc converter connected to the IN pin is disabled but the LDO is still required to regulate the voltage to a light load. These features, combined with low noise, low ground pin current, and ultra-small packaging, make this device ideal for portable applications. This family of regulators offers sub-bandgap output voltages, current limit and thermal protection, and is fully specified from -40°C to $+125^{\circ}\text{C}$.

INPUT AND OUTPUT CAPACITOR REQUIREMENTS

Although an input capacitor is not required for stability on the IN pin, it is good analog design practice to connect a 0.1 μ F to 1.0 μ F low equivalent series resistance (ESR) capacitor across the IN pin input supply near the regulator. This capacitor counteracts reactive input sources and improves transient response, noise rejection, and ripple rejection. A higher-value capacitor may be necessary if large, fast rise-time load transients are anticipated, or if the device is located close to the power source. If source impedance is not sufficiently low, a 0.1 μ F input capacitor may be necessary to ensure stability.

The BIAS pin does not require an input capacitor because it does not source high currents. However, if source impedance is not sufficiently low, a small 0.1 μ F bypass capacitor is recommended.

The TPS720xx is designed to be stable with standard ceramic capacitors with values of 2.2 μ F or larger at the output. X5R- and X7R-type capacitors are best because they have minimal variation in value and ESR over temperature. Maximum ESR should be less than 250m Ω .

BOARD LAYOUT RECOMMENDATIONS TO IMPROVE PSRR AND NOISE PERFORMANCE

To improve ac performance such as PSRR, output noise, and transient response, it is recommended that the board be designed with separate ground planes for V_{IN} and V_{OUT} , with the ground plane connected only at the GND pin of the device. In addition, the

ground connection for the output capacitor should be connected directly to the GND pin of the device. High equivalent series resistance (ESR) capacitors may degrade PSRR. The BIAS pin draws very little current and can be routed as a signal (make sure to shield it from high-frequency coupling).

INTERNAL CURRENT LIMIT

The TPS720xx internal current limits help protect the regulator during fault conditions. During current limit, the output sources a fixed amount of current that is largely independent of output voltage. In such a case, the output voltage is not regulated, and is $V_{OUT} = I_{LIMIT} \times R_{LOAD}$. The NMOS pass transistor dissipates $(V_{IN} - V_{OUT}) \times I_{LIMIT}$ until thermal shut down is triggered and the device is turned off. As the device cools down, it is turned on by the internal thermal shutdown circuit. If the fault condition continues, the device cycles between current limit and thermal shutdown. See the [Thermal Information](#) section for more details.

The NMOS pass element in the TPS720xx has a built-in body diode that conducts current when the voltage at OUT exceeds the voltage at IN. This current is not limited, so if extended reverse voltage operation is anticipated, external limiting to 5% of rated output current is recommended.

INRUSH CURRENT LIMIT

The TPS720xx family of LDO regulators implement a novel inrush current-limit circuit architecture: the current drawn through the IN pin is limited to a finite value. This $I_{INRUSHLIMIT}$ charges the output to its final voltage. All the current drawn through V_{IN} goes to charge the output capacitance when the load is disconnected. The following equation shows the inrush current limit performed by the circuit:

$$I_{LOAD(A)} = I_{INRUSHLIMIT(A)} - C_{OUT(\mu F)} \times 0.0454545(V/\mu s) \quad (1)$$

Assuming a C_{OUT} of 2.2 μ F with the load disconnected (that is, $I_{LOAD} = 0$) the $I_{INRUSHLIMIT}$ is calculated to be 100mA. The inrush current charges the LDO output capacitor. If the output of the LDO regulates to 1.3V, then the LDO charges the output capacitor to the final output value in approximately 28.6 μ s.

Another consideration is when a load is connected to the output of an LDO. The connected load tries to steer a portion of the current away from V_{OUT} . The TPS720xx inrush current-limit circuit employs a new technique that supplies not only the $I_{INRUSHLIMIT}$, but also the additional current needed by the load. If $I_{LOAD} = 350\text{mA}$, then the $I_{INRUSHLIMIT}$ calculates to be approximately 450mA (from [Equation 1](#)).

SHUTDOWN

The enable pin (EN) is active high and is compatible with standard and low voltage, TTL-CMOS levels. When shutdown capability is not required, EN can be connected to the IN pin.

DROPOUT VOLTAGE

The TPS720xx uses a NMOS pass transistor to achieve low dropout. When $(V_{IN} - V_{OUT})$ is less than the dropout voltage (V_{DO}), the NMOS pass device is in the linear region of operation and the input-to-output resistance is the $R_{DS(ON)}$ of the NMOS pass element. V_{DO} approximately scales with output current because the NMOS device behaves as a resistor in dropout.

As with any linear regulator, PSRR and transient response are degraded as $(V_{IN} - V_{OUT})$ approaches dropout. This effect is shown in [Figure 19](#) in the [Typical Characteristics](#) section.

TRANSIENT RESPONSE

As with any regulator, increasing the size of the output capacitor reduces over/undershoot magnitude but increases duration of the transient response.

UNDERVOLTAGE LOCK-OUT (UVLO)

The TPS720xx uses an undervoltage lock-out circuit on the BIAS pin to keep the output shut off until the internal circuitry is operating properly. The UVLO circuit has a deglitch feature so that it typically ignores undershoot transients on the input if they are less than 50 μ s duration.

MINIMUM LOAD

The TPS720xx is stable with no output load. Traditional LDOs suffer from low loop gain at very light output loads. The TPS720xx employs an innovative, low-current mode circuit under very light or no-load conditions, resulting in improved output voltage regulation performance down to zero output current.

OUTPUT REGULATION WITH IN PIN FLOATING

The TPS720xx supports a novel feature in which the output of the LDO regulates under light loads when the IN pin is left floating. Under normal conditions, when the IN pin is connected to a power source, the BIAS pin draws only tens of milliamperes. However, when the IN pin is floating, an innovative circuit is used that allows a maximum current of 500 μ A to be drawn by the load through the BIAS pin, while maintaining the output in regulation. This feature is particularly useful in power-saving applications where a dc/dc converter connected to the IN pin is disabled, but the LDO is required to regulate the output voltage to a light load.

[Figure 27](#) shows an application example where a microcontroller is not turned off (to maintain the state of the internal memory), but where the regulated supply (shown as the TPS62xxx) is turned off to reduce power. In this case, the TPS720xx BIAS pin provides sufficient load current to maintain a regulated voltage to the microcontroller.

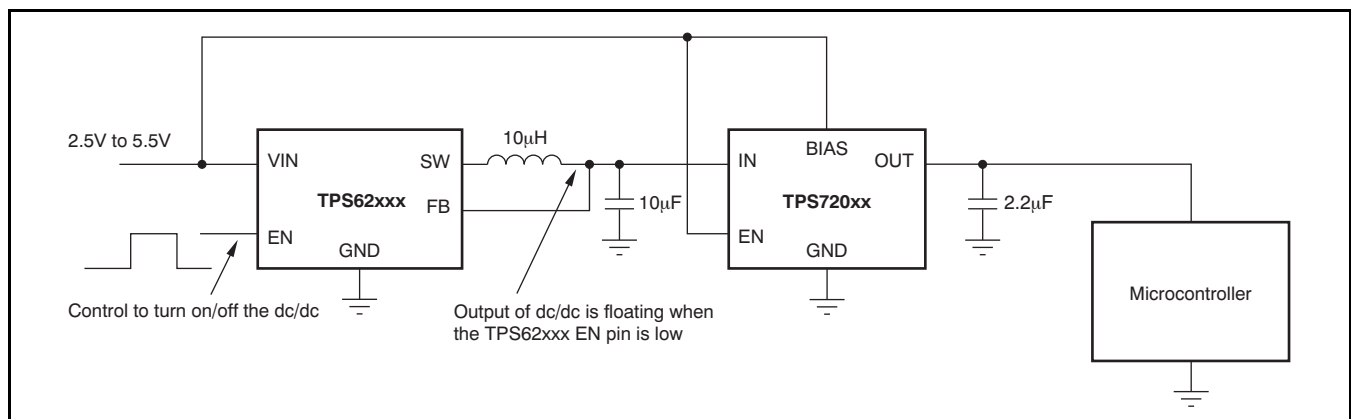

Figure 27. Example of Floating IN Pin Regulation

THERMAL INFORMATION

Thermal protection disables the output when the junction temperature rises to approximately +160°C, allowing the device to cool. When the junction temperature cools to approximately +140°C, the output circuitry is again enabled. Depending on power dissipation, thermal resistance, and ambient temperature, the thermal protection circuit may cycle on and off. This cycling limits the dissipation of the regulator, protecting it from damage as a result of overheating.

Any tendency to activate the thermal protection circuit indicates excessive power dissipation or an inadequate heatsink. For reliable operation, junction temperature should be limited to +125°C maximum. To estimate the margin of safety in a complete design (including heatsink), increase the ambient temperature until the thermal protection is triggered; use worst-case loads and signal conditions. For good reliability, thermal protection should trigger at least +35°C above the maximum expected ambient condition of the particular application. This configuration produces a worst-case junction temperature of +125°C at the highest expected ambient temperature and worst-case load.

The internal protection circuitry of the TPS720xx has been designed to protect against overload conditions. It was not intended to replace proper heatsinking. Continuously running the TPS720xx into thermal shutdown degrades device reliability.

POWER DISSIPATION

The ability to remove heat from the die is different for each package type, presenting different considerations in the printed circuit board (PCB) layout. The PCB area around the device that is free of other components moves the heat from the device to the ambient air. Performance data for JEDEC low- and high-K boards are given in the [Dissipation Ratings](#) table. Using heavier copper increases the effectiveness in removing heat from the device. The addition of plated through-holes to heat-dissipating layers also improves the heatsink effectiveness.

Power dissipation depends on input voltage and load conditions. Power dissipation (P_D) is equal to the product of the output current times the voltage drop across the output pass element (V_{IN} to V_{OUT}), as shown in [Equation 2](#):

$$P_D = (V_{IN} - V_{OUT}) \times I_{OUT} \quad (2)$$

PACKAGE MOUNTING

Solder pad footprint recommendations for the TPS720xx are available from the Texas Instruments web site at www.ti.com.

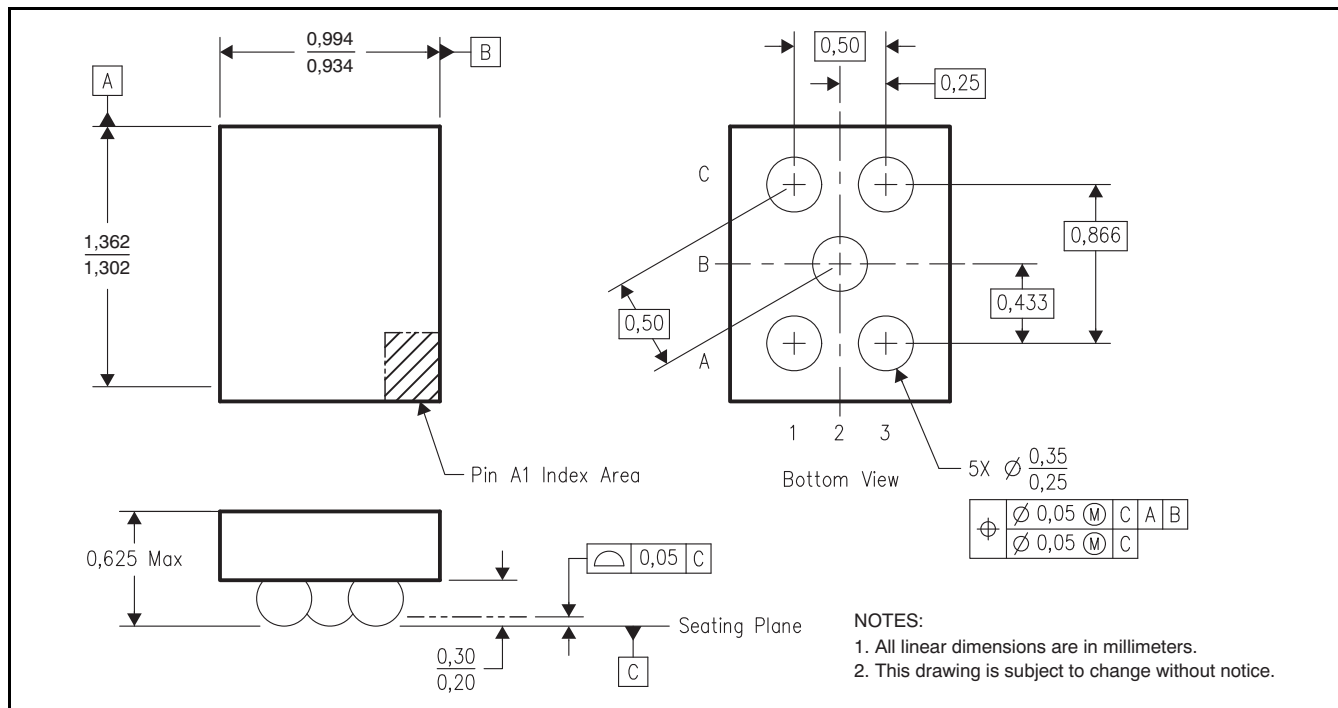

Figure 28. YZU Wafer Chip-Scale Package Dimensions (in mm)

PACKAGING INFORMATION

Orderable Device	Status ⁽¹⁾	Package Type	Package Drawing	Pins	Package Qty	Eco Plan ⁽²⁾	Lead/Ball Finish	MSL Peak Temp ⁽³⁾
TPS720105DRVR	PREVIEW	SON	DRV	6		TBD	Call TI	Call TI
TPS720105DRVT	PREVIEW	SON	DRV	6		TBD	Call TI	Call TI
TPS720105YZUR	PREVIEW	DSBGA	YZU	5	3000	TBD	Call TI	Call TI
TPS720105YZUT	PREVIEW	DSBGA	YZU	5	250	TBD	Call TI	Call TI
TPS72013YZUR	ACTIVE	DSBGA	YZU	5	3000	Green (RoHS & no Sb/Br)	Call TI	Level-1-260C-UNLIM
TPS72013YZUT	ACTIVE	DSBGA	YZU	5	250	Green (RoHS & no Sb/Br)	Call TI	Level-1-260C-UNLIM
TPS72015YZUR	ACTIVE	DSBGA	YZU	5	3000	Green (RoHS & no Sb/Br)	Call TI	Level-1-260C-UNLIM
TPS72015YZUT	ACTIVE	DSBGA	YZU	5	250	Green (RoHS & no Sb/Br)	Call TI	Level-1-260C-UNLIM
TPS72017YZUR	ACTIVE	DSBGA	YZU	5	3000	Green (RoHS & no Sb/Br)	Call TI	Level-1-260C-UNLIM
TPS72017YZUT	ACTIVE	DSBGA	YZU	5	250	Green (RoHS & no Sb/Br)	Call TI	Level-1-260C-UNLIM
TPS72018YZUR	ACTIVE	DSBGA	YZU	5	3000	Green (RoHS & no Sb/Br)	Call TI	Level-1-260C-UNLIM
TPS72018YZUT	ACTIVE	DSBGA	YZU	5	250	Green (RoHS & no Sb/Br)	Call TI	Level-1-260C-UNLIM

⁽¹⁾ The marketing status values are defined as follows:

ACTIVE: Product device recommended for new designs.

LIFEBUY: TI has announced that the device will be discontinued, and a lifetime-buy period is in effect.

NRND: Not recommended for new designs. Device is in production to support existing customers, but TI does not recommend using this part in a new design.

PREVIEW: Device has been announced but is not in production. Samples may or may not be available.

OBSOLETE: TI has discontinued the production of the device.

⁽²⁾ Eco Plan - The planned eco-friendly classification: Pb-Free (RoHS), Pb-Free (RoHS Exempt), or Green (RoHS & no Sb/Br) - please check <http://www.ti.com/productcontent> for the latest availability information and additional product content details.

TBD: The Pb-Free/Green conversion plan has not been defined.

Pb-Free (RoHS): TI's terms "Lead-Free" or "Pb-Free" mean semiconductor products that are compatible with the current RoHS requirements for all 6 substances, including the requirement that lead not exceed 0.1% by weight in homogeneous materials. Where designed to be soldered at high temperatures, TI Pb-Free products are suitable for use in specified lead-free processes.

Pb-Free (RoHS Exempt): This component has a RoHS exemption for either 1) lead-based flip-chip solder bumps used between the die and package, or 2) lead-based die adhesive used between the die and leadframe. The component is otherwise considered Pb-Free (RoHS compatible) as defined above.

Green (RoHS & no Sb/Br): TI defines "Green" to mean Pb-Free (RoHS compatible), and free of Bromine (Br) and Antimony (Sb) based flame retardants (Br or Sb do not exceed 0.1% by weight in homogeneous material)

⁽³⁾ MSL, Peak Temp. -- The Moisture Sensitivity Level rating according to the JEDEC industry standard classifications, and peak solder temperature.

Important Information and Disclaimer:The information provided on this page represents TI's knowledge and belief as of the date that it is provided. TI bases its knowledge and belief on information provided by third parties, and makes no representation or warranty as to the accuracy of such information. Efforts are underway to better integrate information from third parties. TI has taken and continues to take reasonable steps to provide representative and accurate information but may not have conducted destructive testing or chemical analysis on incoming materials and chemicals. TI and TI suppliers consider certain information to be proprietary, and thus CAS numbers and other limited information may not be available for release.

In no event shall TI's liability arising out of such information exceed the total purchase price of the TI part(s) at issue in this document sold by TI to Customer on an annual basis.

TAPE AND REEL INFORMATION



QUADRANT ASSIGNMENTS FOR PIN 1 ORIENTATION IN TAPE



*All dimensions are nominal

Device	Package Type	Package Drawing	Pins	SPQ	Reel Diameter (mm)	Reel Width W1 (mm)	A0 (mm)	B0 (mm)	K0 (mm)	P1 (mm)	W (mm)	Pin1 Quadrant
TPS72013YZUR	DSBGA	YZU	5	3000	178.0	8.4	1.09	1.42	0.81	4.0	8.0	Q1
TPS72013YZUT	DSBGA	YZU	5	250	178.0	8.4	1.09	1.42	0.81	4.0	8.0	Q1
TPS72015YZUR	DSBGA	YZU	5	3000	178.0	8.4	1.09	1.42	0.81	4.0	8.0	Q1
TPS72015YZUT	DSBGA	YZU	5	250	178.0	8.4	1.09	1.42	0.81	4.0	8.0	Q1
TPS72017YZUR	DSBGA	YZU	5	3000	178.0	8.4	1.09	1.42	0.81	4.0	8.0	Q1
TPS72017YZUT	DSBGA	YZU	5	250	178.0	8.4	1.09	1.42	0.81	4.0	8.0	Q1
TPS72018YZUR	DSBGA	YZU	5	3000	178.0	8.4	1.09	1.42	0.81	4.0	8.0	Q1
TPS72018YZUT	DSBGA	YZU	5	250	178.0	8.4	1.09	1.42	0.81	4.0	8.0	Q1

TAPE AND REEL BOX DIMENSIONS



*All dimensions are nominal

Device	Package Type	Package Drawing	Pins	SPQ	Length (mm)	Width (mm)	Height (mm)
TPS72013YZUR	DSBGA	YZU	5	3000	217.0	193.0	35.0
TPS72013YZUT	DSBGA	YZU	5	250	217.0	193.0	35.0
TPS72015YZUR	DSBGA	YZU	5	3000	217.0	193.0	35.0
TPS72015YZUT	DSBGA	YZU	5	250	217.0	193.0	35.0
TPS72017YZUR	DSBGA	YZU	5	3000	217.0	193.0	35.0
TPS72017YZUT	DSBGA	YZU	5	250	217.0	193.0	35.0
TPS72018YZUR	DSBGA	YZU	5	3000	217.0	193.0	35.0
TPS72018YZUT	DSBGA	YZU	5	250	217.0	193.0	35.0

DRV (S-PDSO-N6)

PLASTIC SMALL OUTLINE

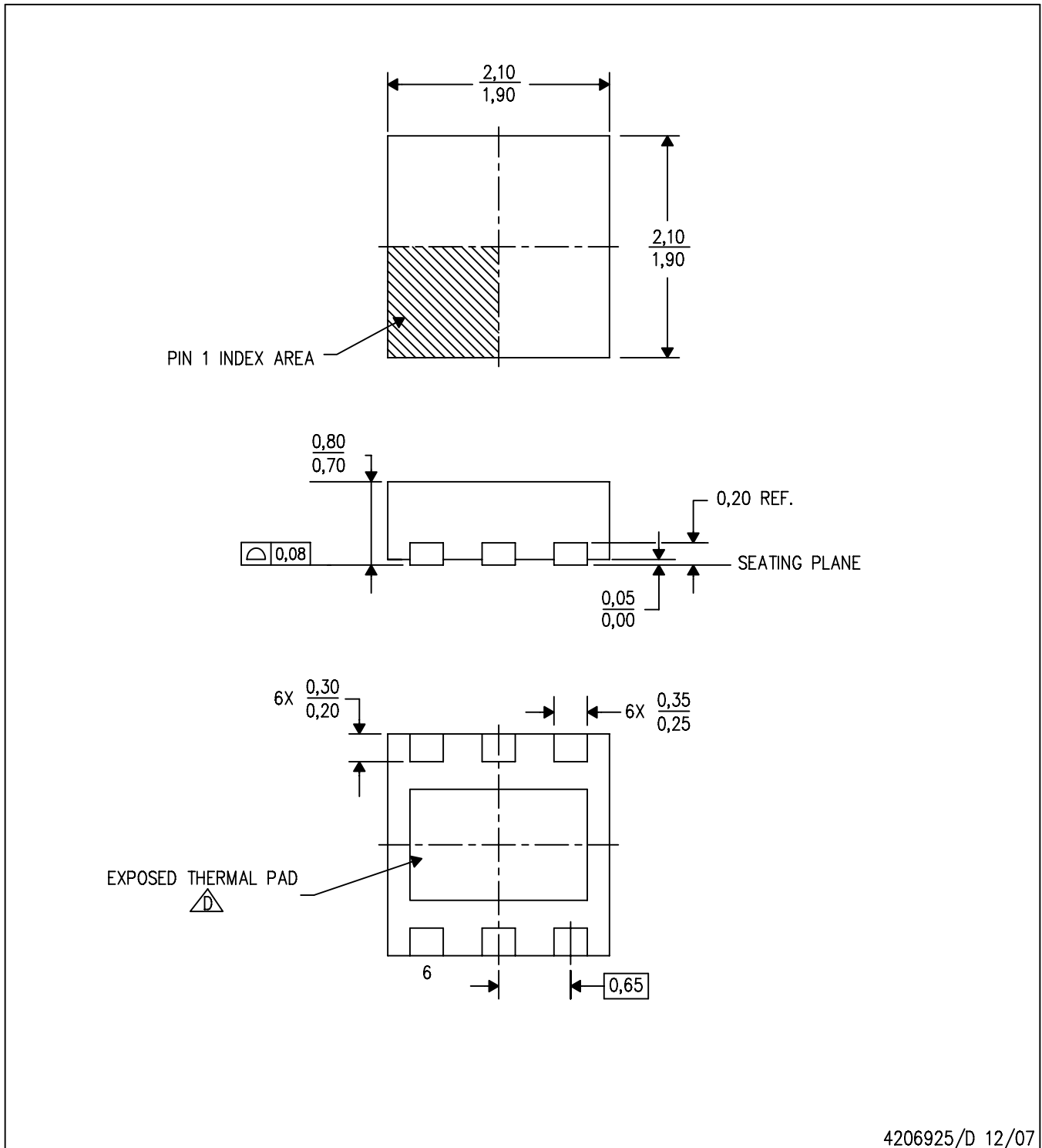

4206925/D 12/07

- NOTES:
- A. All linear dimensions are in millimeters. Dimensioning and tolerancing per ASME Y14.5M-1994.
 - B. This drawing is subject to change without notice.
 - C. Small Outline No-Lead (SON) package configuration.
-  The package thermal pad must be soldered to the board for thermal and mechanical performance. See the Product Data Sheet for details regarding the exposed thermal pad dimensions.

THERMAL INFORMATION

This package incorporates an exposed thermal pad that is designed to be attached directly to an external heatsink. The thermal pad must be soldered directly to the printed circuit board (PCB). After soldering, the PCB can be used as a heatsink. In addition, through the use of thermal vias, the thermal pad can be attached directly to the appropriate copper plane shown in the electrical schematic for the device, or alternatively, can be attached to a special heatsink structure designed into the PCB. This design optimizes the heat transfer from the integrated circuit (IC).

For information on the Quad Flatpack No-Lead (QFN) package and its advantages, refer to Application Report, Quad Flatpack No-Lead Logic Packages, Texas Instruments Literature No. SCBA017. This document is available at www.ti.com.

The exposed thermal pad dimensions for this package are shown in the following illustration.

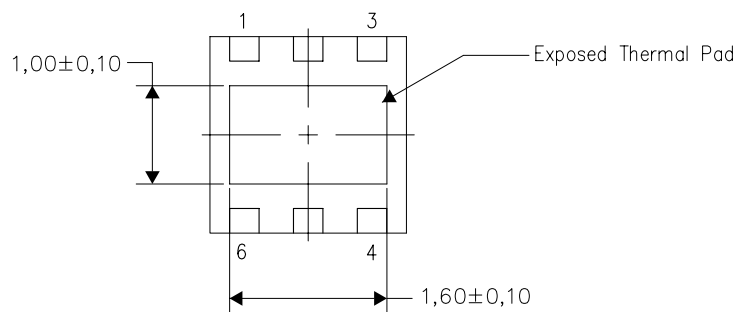

Bottom View

NOTE: All linear dimensions are in millimeters

Exposed Thermal Pad Dimensions

DRV (S-PDSO-N6)

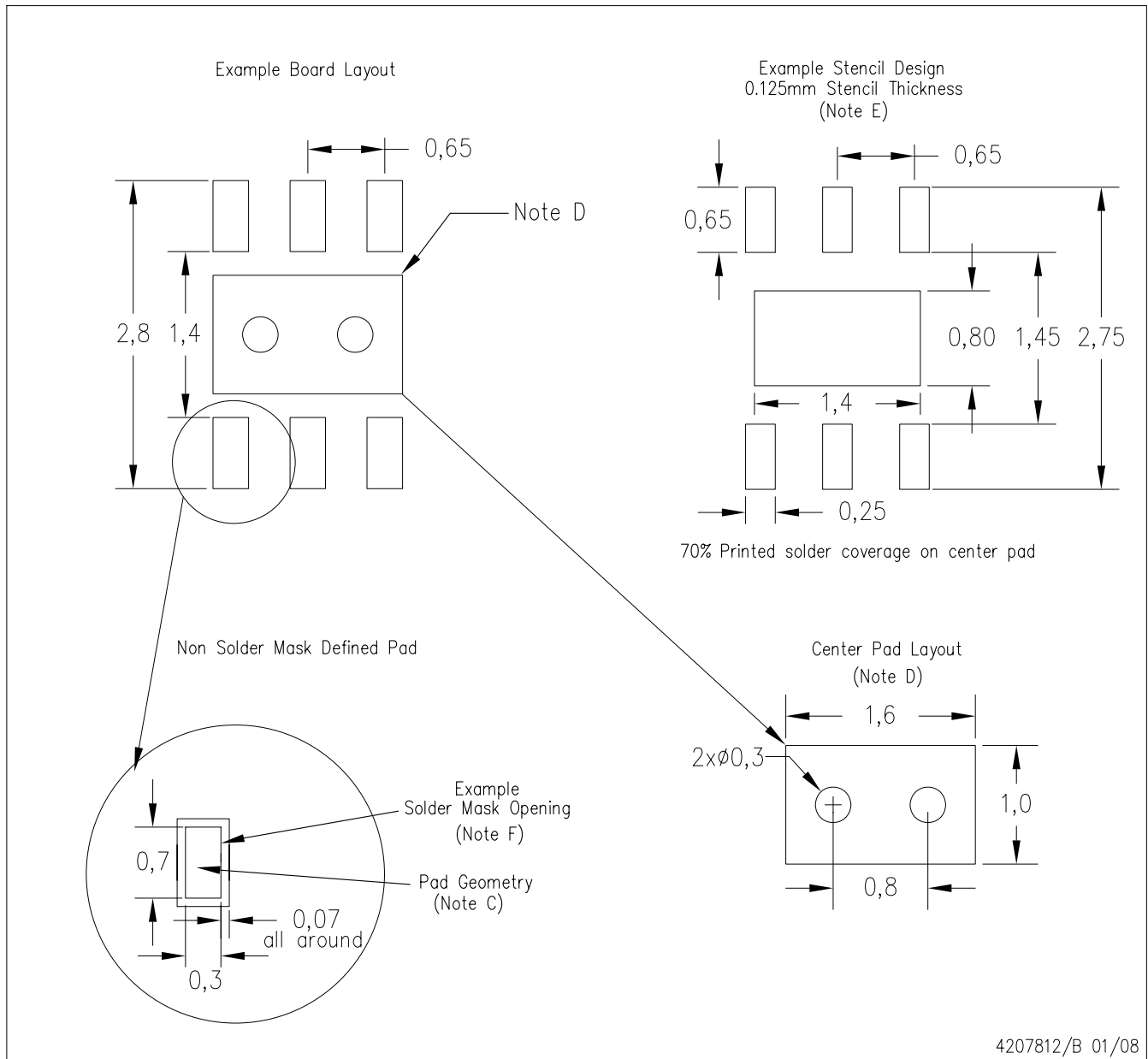

- NOTES:
- A. All linear dimensions are in millimeters.
 - B. This drawing is subject to change without notice.
 - C. Publication IPC-7351 is recommended for alternate designs.
 - D. This package is designed to be soldered to a thermal pad on the board. Refer to Application Note, QFN Packages, Texas Instruments Literature No. SCBA017, SLUA271, and also the Product Data Sheets for specific thermal information, via requirements, and recommended board layout. These documents are available at www.ti.com <<http://www.ti.com>>.
 - E. Laser cutting apertures with trapezoidal walls and also rounding corners will offer better paste release. Customers should contact their board assembly site for stencil design recommendations. Refer to IPC 7525 for stencil design considerations.
 - F. Customers should contact their board fabrication site for solder mask tolerances.

YZU (R-XBGA-N5)

DIE-SIZE BALL GRID ARRAY

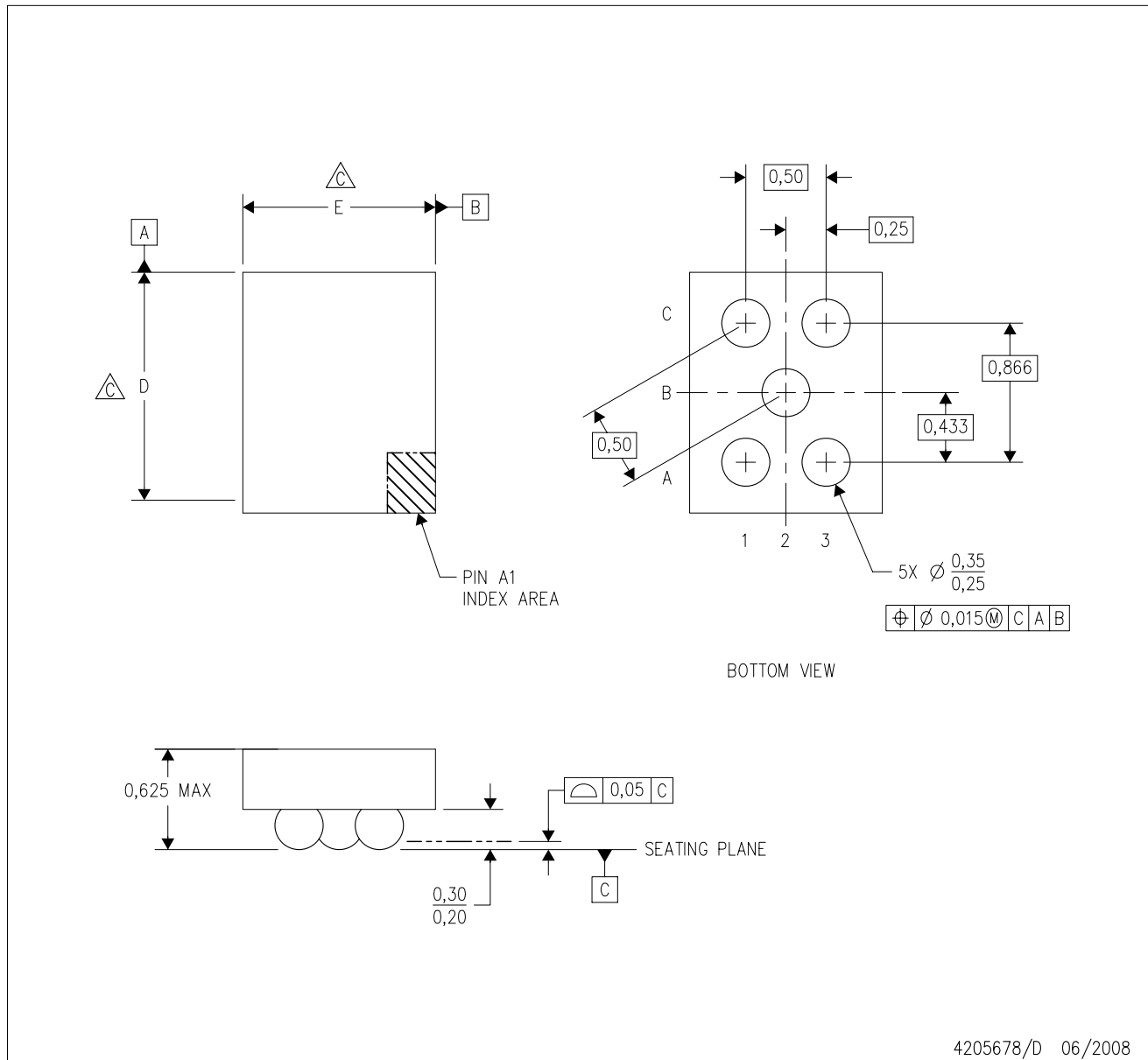

- Notes:
- A. All linear dimensions are in millimeters.
 - B. This drawing is subject to change without notice.
 - $\triangle C$ Devices in this YZQ package can have dimension D ranging from 1.31 to 1.75 mm and dimension E ranging from 0.94 to 1.45 mm. To determine the exact package size of a particular device, refer to the device datasheet or contact a local TI representative.
 - D. NanoFree™ package configuration.
 - E. This package contains lead-free balls. Refer to the 5 YEU package (drawing 4205430) for tin-lead (SnPb) balls.

NanoFree is a trademark of Texas Instruments.

IMPORTANT NOTICE

Texas Instruments Incorporated and its subsidiaries (TI) reserve the right to make corrections, modifications, enhancements, improvements, and other changes to its products and services at any time and to discontinue any product or service without notice. Customers should obtain the latest relevant information before placing orders and should verify that such information is current and complete. All products are sold subject to TI's terms and conditions of sale supplied at the time of order acknowledgment.

TI warrants performance of its hardware products to the specifications applicable at the time of sale in accordance with TI's standard warranty. Testing and other quality control techniques are used to the extent TI deems necessary to support this warranty. Except where mandated by government requirements, testing of all parameters of each product is not necessarily performed.

TI assumes no liability for applications assistance or customer product design. Customers are responsible for their products and applications using TI components. To minimize the risks associated with customer products and applications, customers should provide adequate design and operating safeguards.

TI does not warrant or represent that any license, either express or implied, is granted under any TI patent right, copyright, mask work right, or other TI intellectual property right relating to any combination, machine, or process in which TI products or services are used. Information published by TI regarding third-party products or services does not constitute a license from TI to use such products or services or a warranty or endorsement thereof. Use of such information may require a license from a third party under the patents or other intellectual property of the third party, or a license from TI under the patents or other intellectual property of TI.

Reproduction of TI information in TI data books or data sheets is permissible only if reproduction is without alteration and is accompanied by all associated warranties, conditions, limitations, and notices. Reproduction of this information with alteration is an unfair and deceptive business practice. TI is not responsible or liable for such altered documentation. Information of third parties may be subject to additional restrictions.

Resale of TI products or services with statements different from or beyond the parameters stated by TI for that product or service voids all express and any implied warranties for the associated TI product or service and is an unfair and deceptive business practice. TI is not responsible or liable for any such statements.

TI products are not authorized for use in safety-critical applications (such as life support) where a failure of the TI product would reasonably be expected to cause severe personal injury or death, unless officers of the parties have executed an agreement specifically governing such use. Buyers represent that they have all necessary expertise in the safety and regulatory ramifications of their applications, and acknowledge and agree that they are solely responsible for all legal, regulatory and safety-related requirements concerning their products and any use of TI products in such safety-critical applications, notwithstanding any applications-related information or support that may be provided by TI. Further, Buyers must fully indemnify TI and its representatives against any damages arising out of the use of TI products in such safety-critical applications.

TI products are neither designed nor intended for use in military/aerospace applications or environments unless the TI products are specifically designated by TI as military-grade or "enhanced plastic." Only products designated by TI as military-grade meet military specifications. Buyers acknowledge and agree that any such use of TI products which TI has not designated as military-grade is solely at the Buyer's risk, and that they are solely responsible for compliance with all legal and regulatory requirements in connection with such use.

TI products are neither designed nor intended for use in automotive applications or environments unless the specific TI products are designated by TI as compliant with ISO/TS 16949 requirements. Buyers acknowledge and agree that, if they use any non-designated products in automotive applications, TI will not be responsible for any failure to meet such requirements.

Following are URLs where you can obtain information on other Texas Instruments products and application solutions:

Products

Amplifiers	amplifier.ti.com
Data Converters	dataconverter.ti.com
DSP	dsp.ti.com
Clocks and Timers	www.ti.com/clocks
Interface	interface.ti.com
Logic	logic.ti.com
Power Mgmt	power.ti.com
Microcontrollers	microcontroller.ti.com
RFID	www.ti-rfid.com
RF/IF and ZigBee® Solutions	www.ti.com/lprf

Applications

Audio	www.ti.com/audio
Automotive	www.ti.com/automotive
Broadband	www.ti.com/broadband
Digital Control	www.ti.com/digitalcontrol
Medical	www.ti.com/medical
Military	www.ti.com/military
Optical Networking	www.ti.com/opticalnetwork
Security	www.ti.com/security
Telephony	www.ti.com/telephony
Video & Imaging	www.ti.com/video
Wireless	www.ti.com/wireless

Mailing Address: Texas Instruments, Post Office Box 655303, Dallas, Texas 75265
Copyright © 2008, Texas Instruments Incorporated